

PV-10.14.25-PP 0888081

Primary Usage

Reference No.

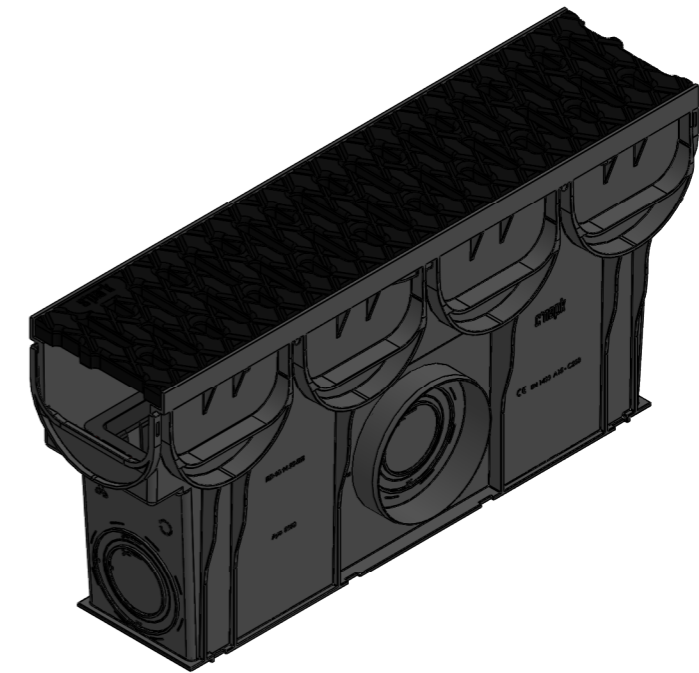
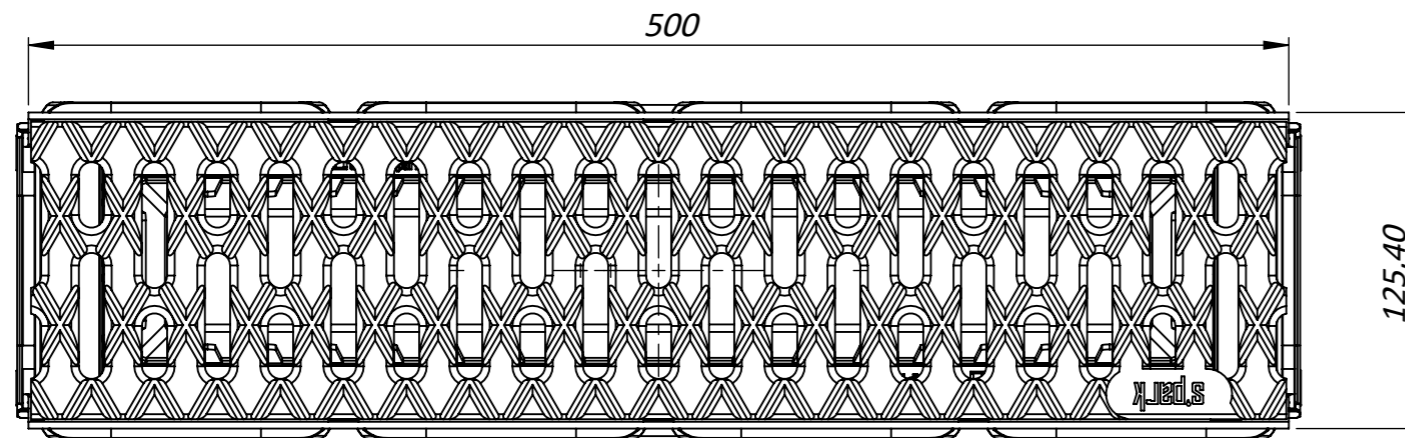
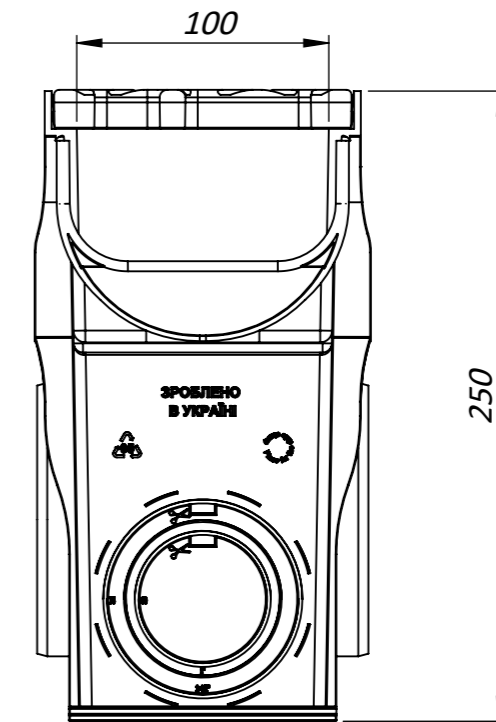
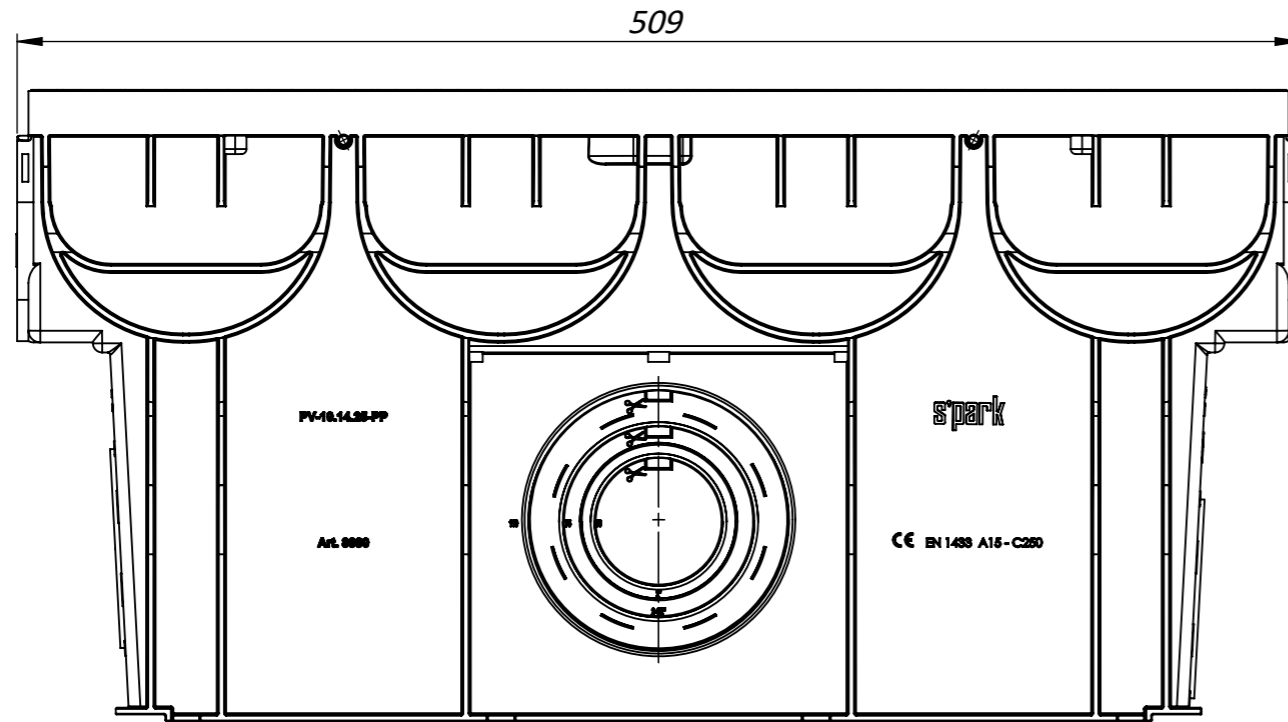

Sign. and date

Copy inv. No.

Repl. Inv. No.

Sign. and date

Orig. Inv. No.

1. Deviation of the actual weight of the nominal can be up to 12%

					Art.	0888081
					PV-10.14.25-PP 0888081	
					Let.	Weight
						Scale
						1,56
						1:3
					Sheet	Sheets 1
					Plastic	